

Informacja o produkcji

Roto NX Zasuwnice EasyMix

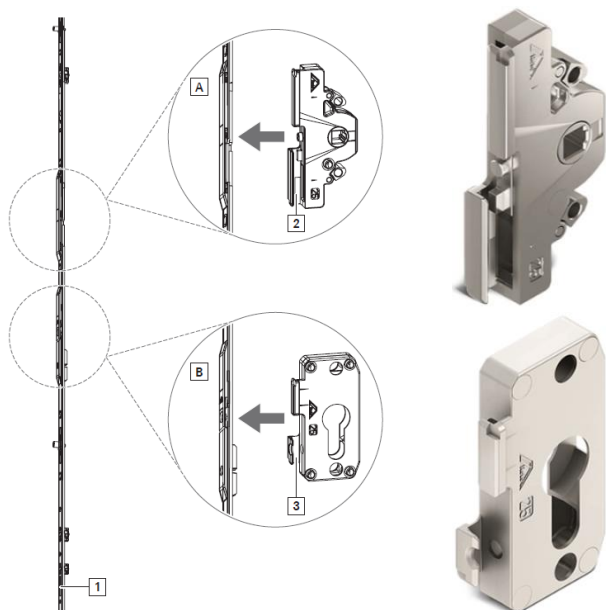

Opis

System EasyMix przeznaczony jest do zasuwnic z dużym dornmasem. System zapewnia znaczną redukcję stanów magazynowych.

Dane techniczne

- przeznaczenie do dornmasów 25/30/35/40/45/50mm
- od dornmasu 25mm listwa i kasetka zasuwniczy/kasetka zamka są oddzielne
- prosty sposób łączenia – elementy są zatraskiwane na zasuwnicę, bez użycia wkrętów

Zastosowanie

W Roto NX do zasuwnic o dużym dornmasie.

Dokumentacja

Artykuł dostępny w katalogu Roto NX CTL_105

Montaż

Kasetę zasuwniczy/kasetę zamka należy włożyć w listwę zasuwniczy. Następnie obracać zgodnie z kierunkiem ruchu wskazówek zegara, aż do zatrzaśnięcia kasety/zamka. Montaż wg instrukcji IMO_455.

Lista artykułów*

Ze względu na ilość danych tabela z zestawieniem zasuwnic NT oraz odpowiedników w systemie EasyMix znajduje się w linku: [PI 18_3004_Zasuwnice_EasyMix – zestawienie.pdf](#)

Dostępność

Wymiana zasuwnic będzie przebiegała automatycznie od 01.11.2019 po wyczerpaniu zapasów na zasuwnicach NT.

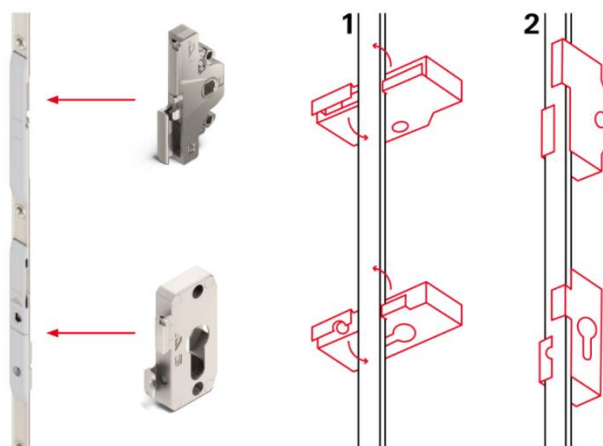

PI_18-3004













Data publikacji: 2019-10-04
Data ostatniej edycji: 2019-10-04

* w przypadku zapytań o cenę prosimy o kontakt: sprzedaz@roto-frank.com

** w przypadku zainteresowania produktem prosimy o zgłaszanie zapotrzebowania oraz oczekiwanego terminu realizacji na adres: sprzedaz@roto-frank.com







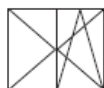

Listwa zasuwnicy - środkowe/zmienne osadzenie klamki



											
Zabezpieczenie podstawowe	520 – 620	400	75 / 75	260 - 310	N	N	N	-	-	Roto Sil	788316
	621 – 800	580	90 / 90	311 - 400	N	T	N	1	E	Roto Sil	788318
	801 – 1200	980	200 / 200	401 - 600	N	T	N	1	E	Roto Sil	788320
	1201 – 1600	1380	200 / 200	601 - 800	N	T	N	2	E	Roto Sil	788322
	1601 – 2000	1780	200 / 200	801 - 1000	N	T	T	2	E	Roto Sil	788324
	2001 – 2400	2180	200 / 200	1001 - 1200	N	T	T	4	E	Roto Sil	788326
Zabezpieczenie antywyważeniowe	1601 – 2000	1780	200 / 200	801 - 1000	N	T	T	2	V	Roto Sil	795365
	2001 – 2400	2180	200 / 200	1001 - 1200	N	T	T	4	V	Roto Sil	795367

Listwa zasuwnicy - środkowe/zmienne osadzenie klamki, skrzydło otwierane jako drugie



							
801 – 1200	980	200 / 200	401 - 600	N	1	Roto Sil	788319
1201 – 1600	1380	200 / 200	601 - 800	N	2	Roto Sil	788321
1601 – 2000	1780	200 / 200	801 - 1000	T	2	Roto Sil	788323
2001 – 2400	2180	200 / 200	1001 - 1200	T	4	Roto Sil	788325

Informacja o produkcji

Roto NX
Zasuwnice EasyMix



Listwa zasuwicy - stałe osadzenie klamki



												N ^o	
Zabezpieczenie podstawowe	601 – 800	690	200	263	N	T	N	-	-	-	-	788302	
	801 – 1000	890	200	413	N	T	N	1	E	-	-	788303	
	1001 – 1200	1090	200	513	N	T	N	1	E	-	-	788304	
	1201 – 1400	1290	200	563	N	T	N	1	E	-	-	788305	
	1401 – 1600	1490	200	563	N	T	N	2	E	-	-	788306	
	1601 – 1800	1690	200	563	N	T	N	2	E	-	-	-	788307
			200	1000	N	T	T	2	E	-	-	-	788308
			200	1000	T	T	T	2	E	-	-	-	788618
	1801 – 2000	1890	200	1000	T	T	T	2	E	-	-	788309	
	2001 – 2200	2090	200	1000	T	T	T	3	E	-	-	788310	
2201 – 2400	2290	200	1000	T	T	T	3	E	-	-	788311		
Zabezpieczenie antywyrwane- niowe	801 – 1000	890	200	413	N	T	N	1	V	-	-	795284	
	1001 – 1200	1090	200	513	N	T	N	1	V	-	-	795285	
	1201 – 1400	1290	200	563	N	T	N	1	V	-	-	795286	
	1401 – 1600	1490	200	563	N	T	N	2	V	-	-	795287	
	1601 – 1800	1690	200	563	N	T	N	2	V	-	-	-	795288
			200	1000	N	T	T	2	V	-	-	-	788312
	1801 – 2000	1890	200	1000	T	T	T	2	V	-	-	788313	
	2001 – 2200	2090	200	1000	T	T	T	3	V	-	-	788314	
2201 – 2400	2290	200	1000	T	T	T	3	V	-	-	788315		

Kaseta zasuwicy

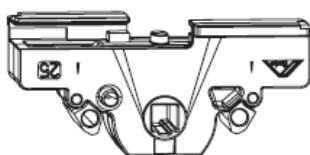

		N ^o
25	Roto Sil	787675
30	Roto Sil	787677
35	Roto Sil	787678
40	Roto Sil	787679
45	Roto Sil	787680
50	Roto Sil	787681

Informacja o produkcji



Roto NX Zasuwnice EasyMix

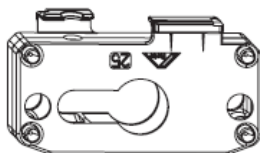

Kaseta zamka

Wkładka bębnowa profilowana



		N ^o
25	Roto Sil	787656
30	Roto Sil	787658
35	Roto Sil	787659
40	Roto Sil	787660
45	Roto Sil	787661
50	Roto Sil	787663

PI_18-3004

Data publikacji: 2019-10-04
Data ostatniej edycji: 2019-10-04

* w przypadku zapytań o cenę prosimy o kontakt: sprzedaz@roto-frank.com

** w przypadku zainteresowania produktem prosimy o zgłaszanie zapotrzebowania oraz oczekiwanego terminu realizacji na adres: sprzedaz@roto-frank.com